



# LEICA VARIO-ELMARIT-R 28-90 mm f/2,8-4,5 ASPH.



The LEICA VARIO-ELMARIT-R 28-90mm f/2.8-4.5 ASPH. is a truly universal lens, which covers a broad range of focal lengths but still proves very fast. It is a lens which, although very compact, offers considerable versatility for practical photography. It will allow you to handle the vast majority of photographic situations and subjects without having to carry any other lenses with you. Its performance matches that of fixed focal lengths lenses and its size is also very compact. As a result, the combination of a camera and this lens gives you a compact Leica R system, suitable for most subjects and situations.

## — Lens shape 28 mm

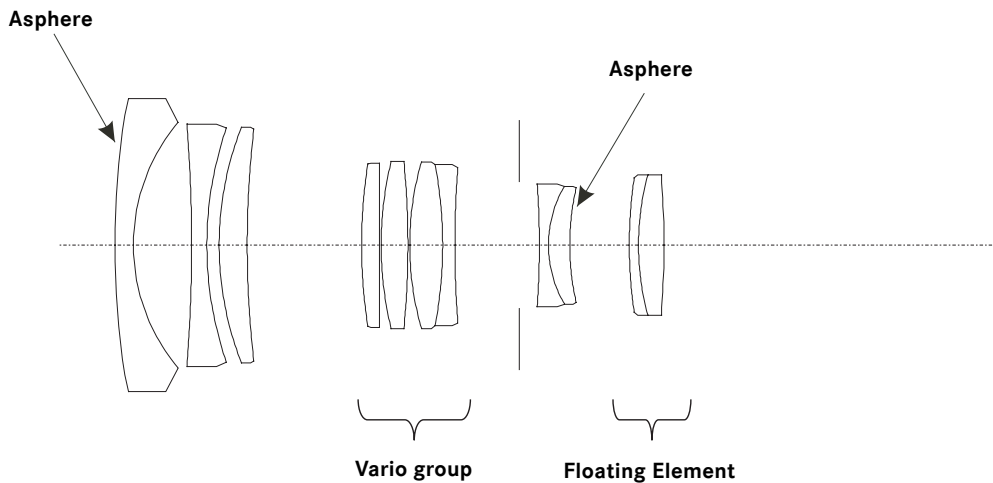



— Lens shape 35 mm

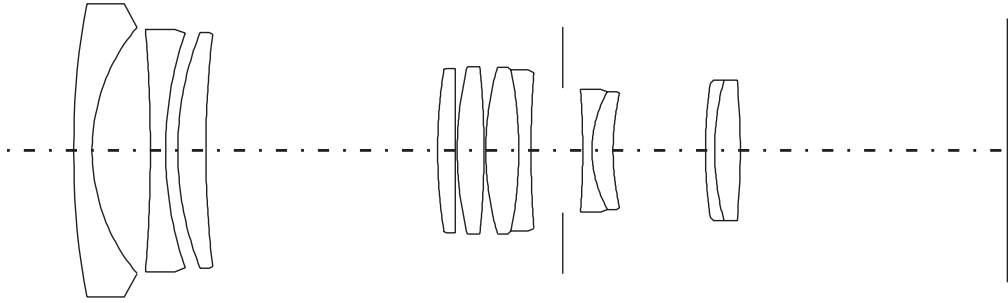

— Lens shape 50 mm

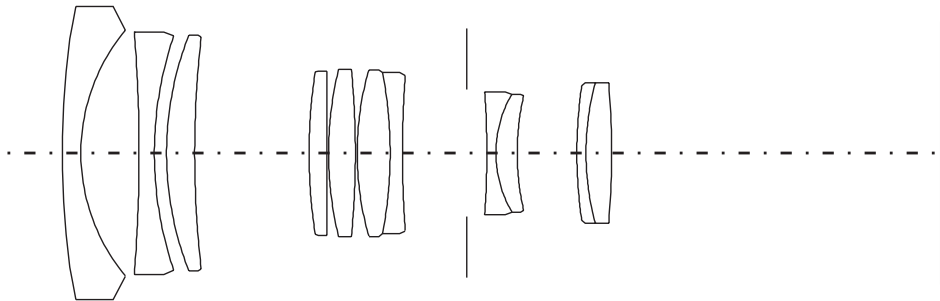

— Lens shape 70 mm

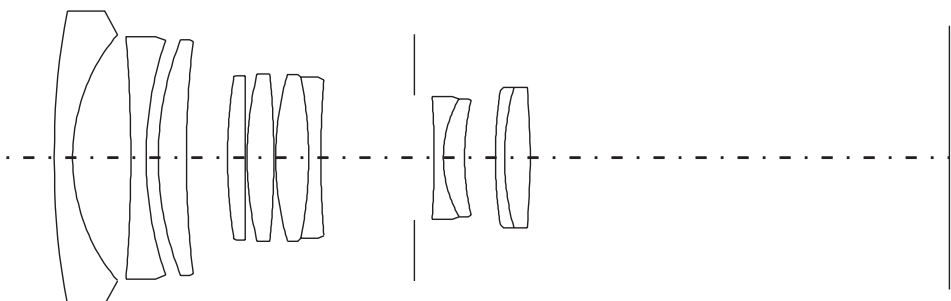



LEICA VARIO-ELMARIT-R 28-90 mm f/2,8-4,5 ASPH.

— Lens shape 90 mm

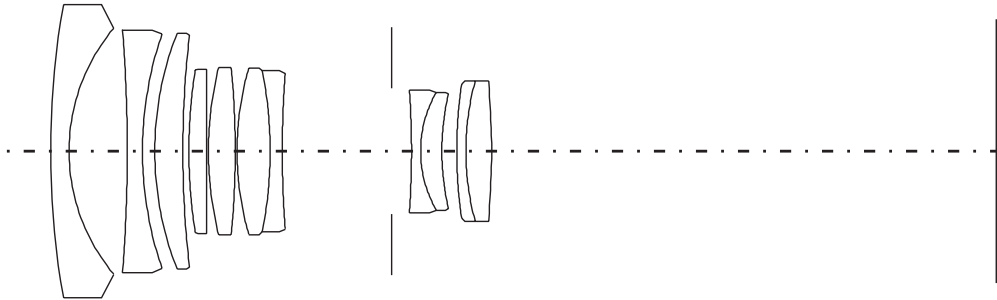



— Engineering drawing

#### Technical Data

<b>Angle of view (diagonal, horizontal, vertical)</b>	Focal length 28 mm: 73.4°, 63.6°, 44.9° Focal length 90 mm: 27.6°, 23.1°, 15.5°
<b>Optical design</b>	<b>Number of elements / groups:</b> 11 / 8 <b>Arbeitsbereich:</b> 0,6 m bis unendlich
<b>Distance setting</b>	<b>Scale:</b> Combined meter/feet-increments <b>Smallest object field:</b> 28 mm focal length: 400 x 600 mm, 90 mm focal length: 133 x 200mm <b>Highest reproduction ratio:</b> 28 mm focal length: 1:16.7, 90 mm focal length: 1:5.5
<b>Diaphragm</b>	<b>Setting / Type:</b> Preset diaphragm with clickstops (including half values), Fully automatic diaphragm <b>Smallest aperture:</b> f/22
<b>Bayonet</b>	LEICA R quick-change bayonet for LEICA R3 to LEICA R9 with mechanical, and, for LEICA R8/R9, additional electronic exposure control
<b>Filter (type)</b>	Internal thread for screw-in type filters E 67
<b>Lens hood</b>	Built-in, pull-out, petal shaped sections
<b>Dimensions and weight</b>	<b>Length:</b> ca. 99 mm <b>Largest diameter:</b> ca. 80 mm <b>Weight:</b> ca. 740 g



— MTF graphs 28 mm

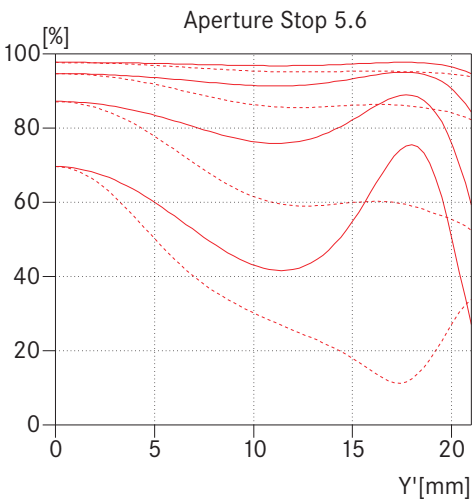
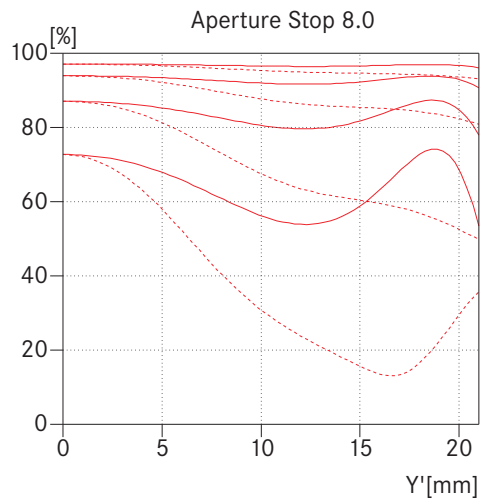
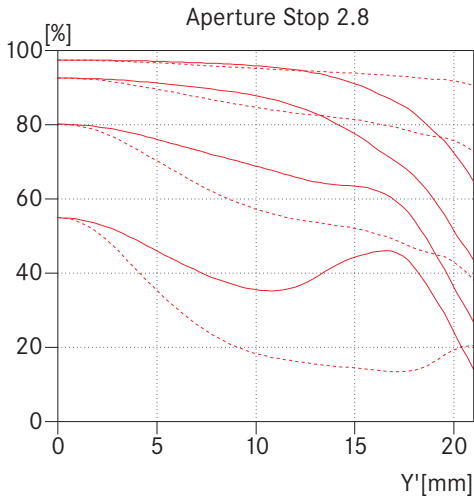

The MTF is indicated both at full aperture and at f/5.6 at long taking distances (infinity). Shown is the contrast in percentage for 5, 10, 20 and 40 lp/mm across the height of the 35 mm film format, for tangential (dotted line) and sagittal (solid line) structures, in white light. The 5 and 10 lp/mm will give an indication regarding the contrast ratio for large object structures. The 20 and 40 lp/mm records the resolution of finer and finest object structures.

- sagittal structures
- - - tangential structures

— Distortion 28 mm

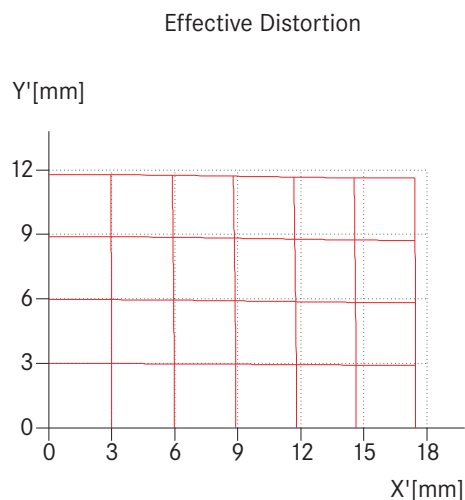
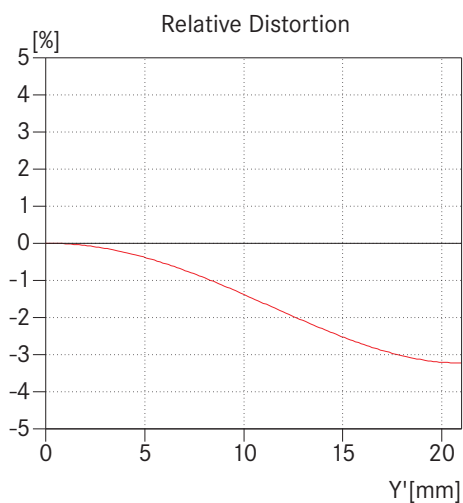

— Vignetting 28 mm

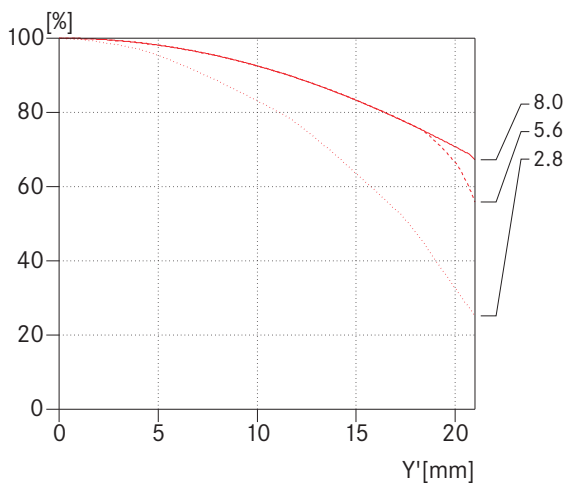

Distortion is the deviation of the real image height (in the picture) from the ideal image height. The relative distortion is the percentage deviation. The ideal image height results from the object height and the magnification. The image height of 21.6mm is the radial distance between the edge and the middle of the image field for the format 24mm x 36mm. The graph of the effective distortion illustrates the appearance of straight horizontal and vertical lines in the picture.

Vignetting is a continuous decrease of the illumination to the edges of the image field. The graph shows the percentage lost of illumination over the image height. 100% means no vignetting.

- sagittal structures
- - - tangential structures



— 35 mm

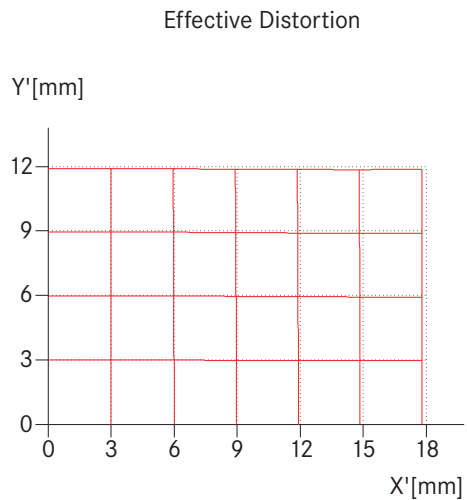
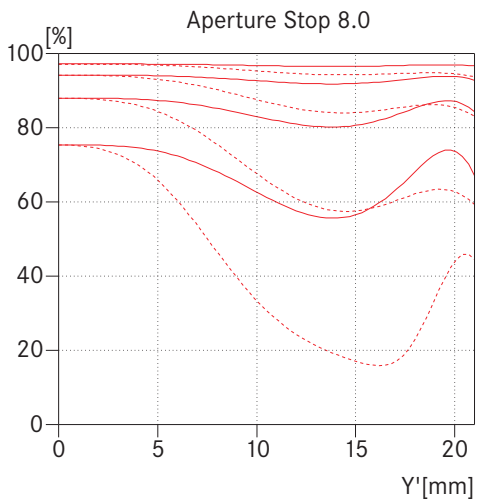
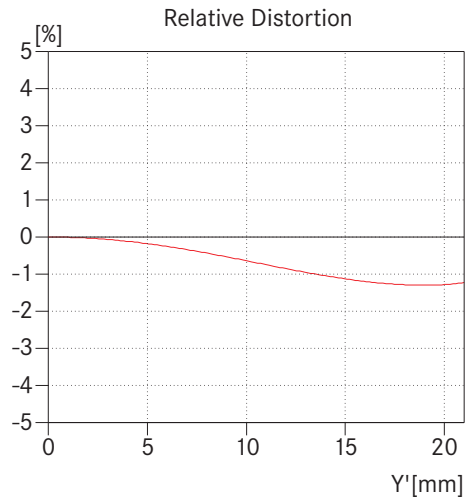
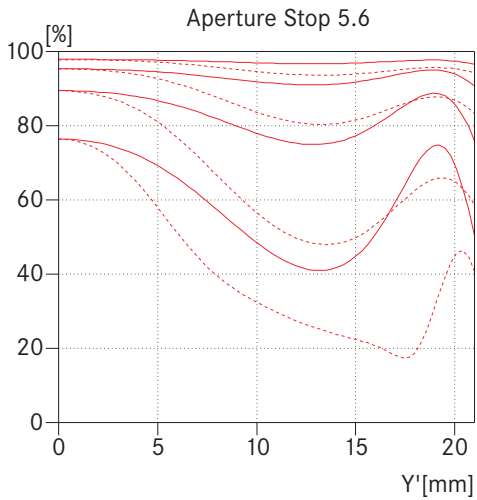
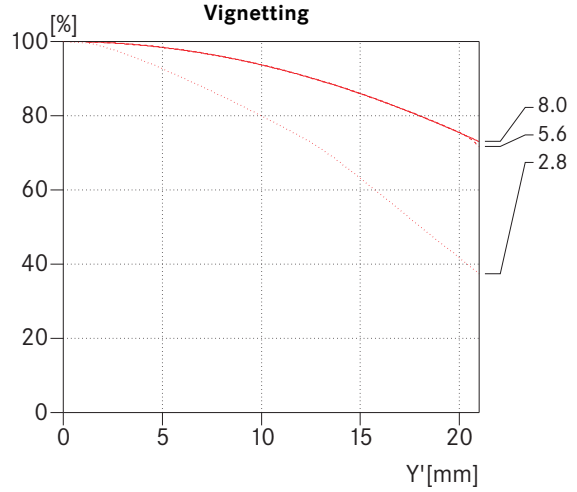
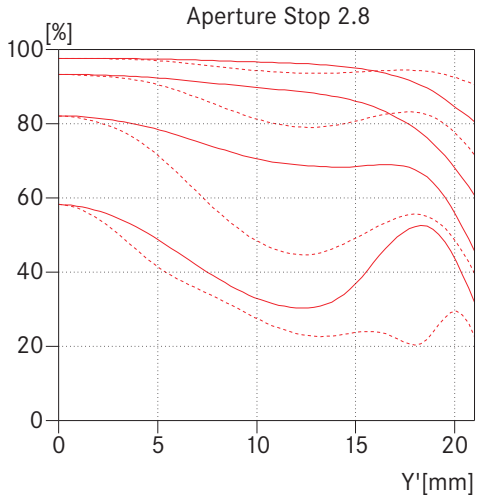



— 50 mm

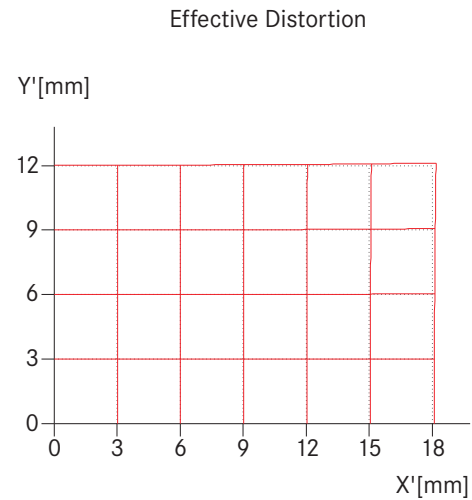
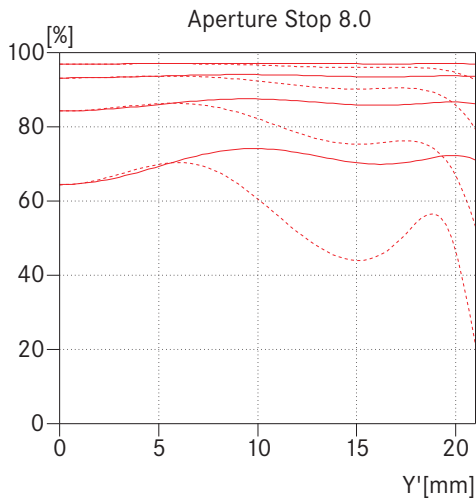
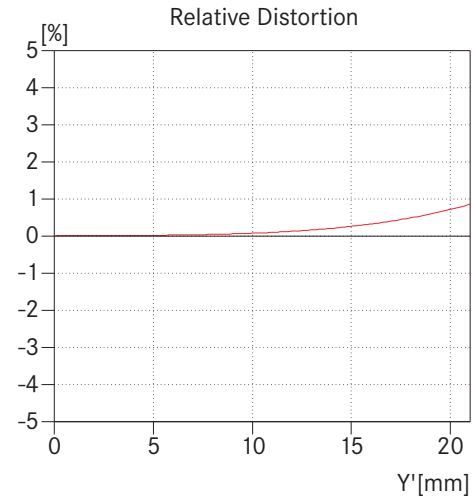
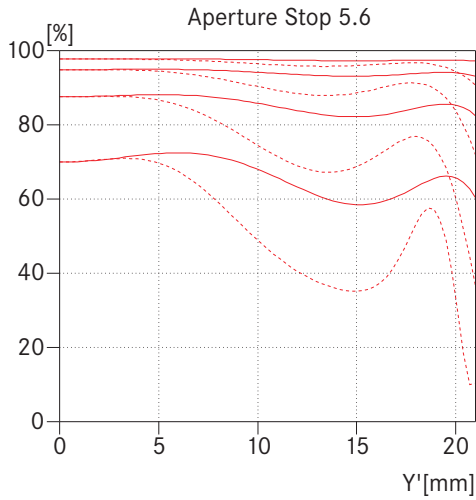
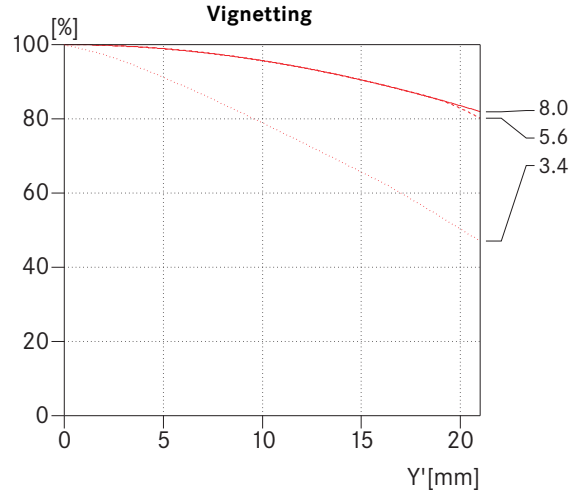
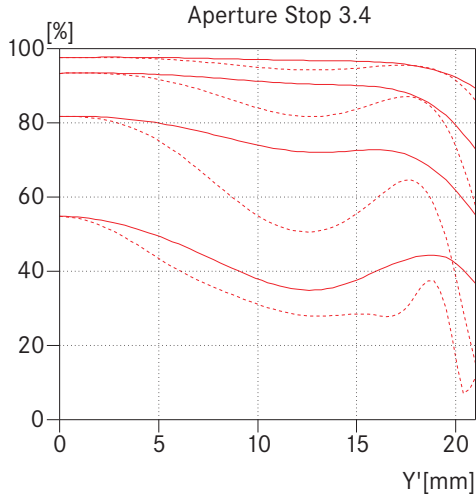





— 70 mm

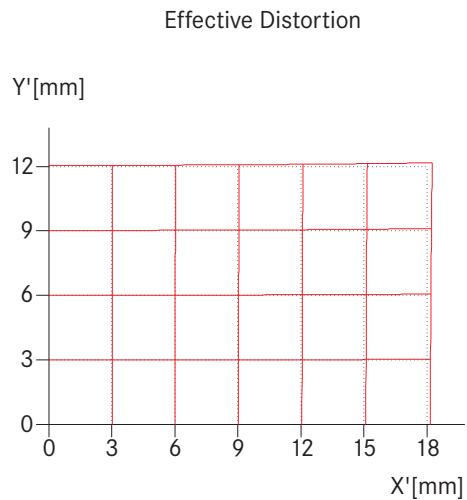
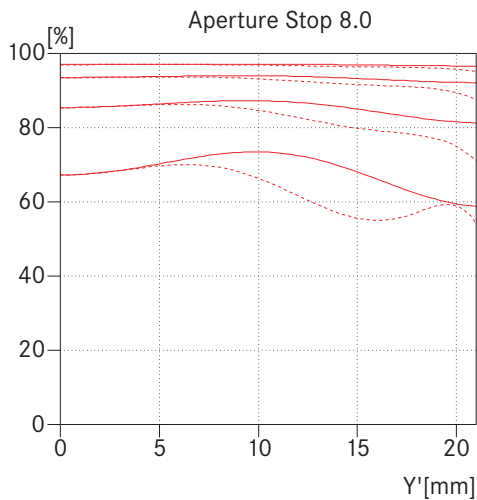
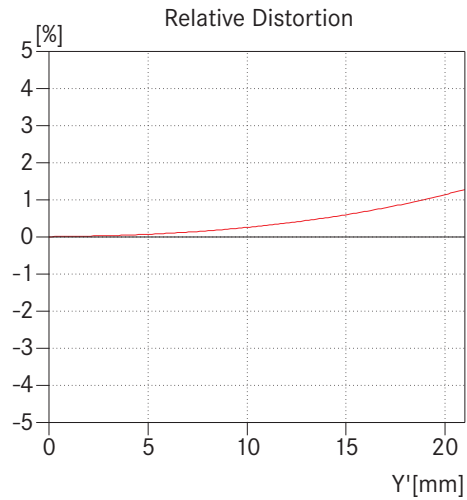
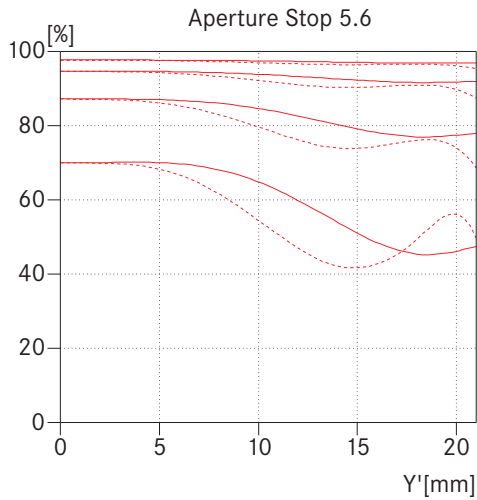
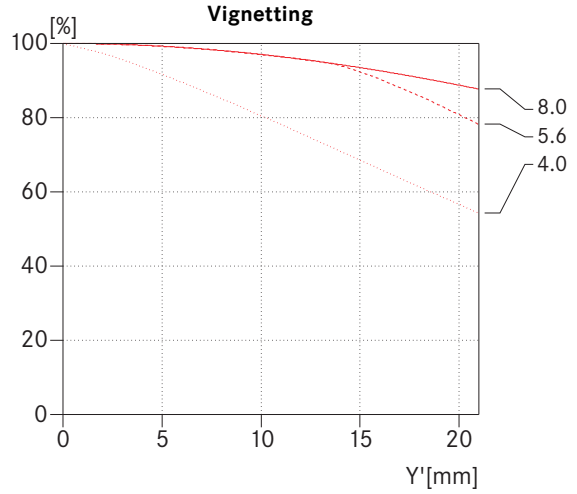
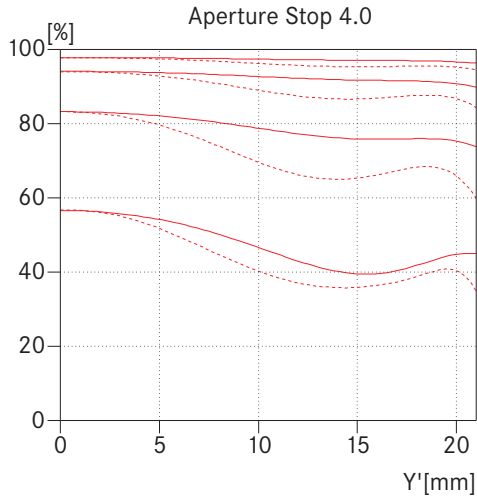



— 90 mm

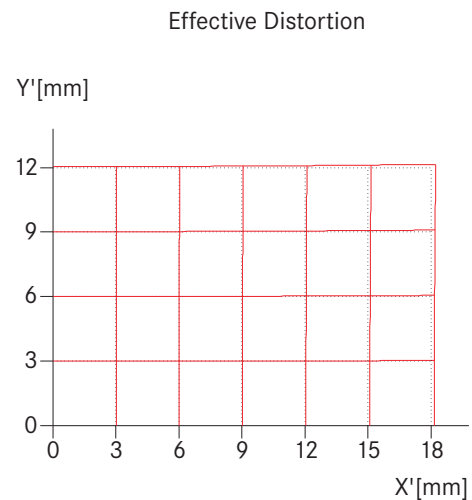
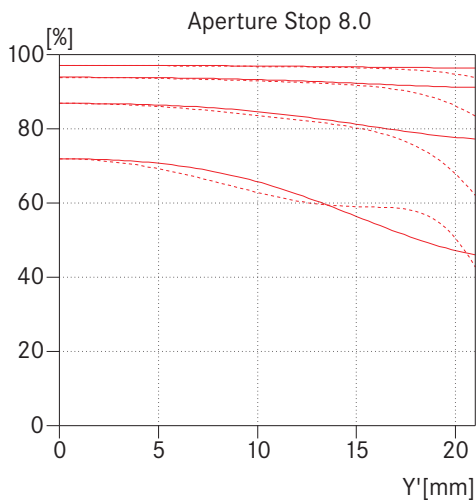
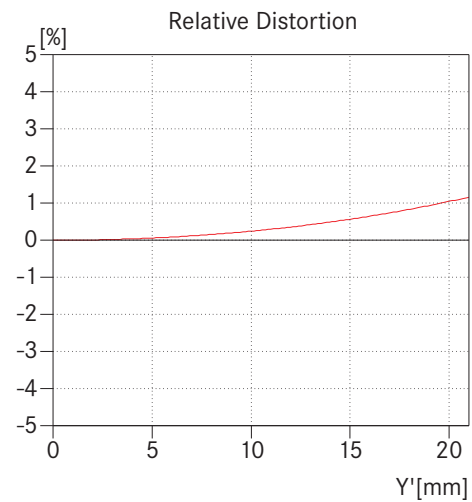
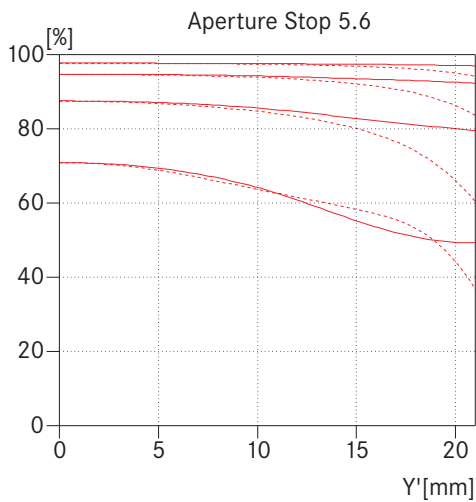
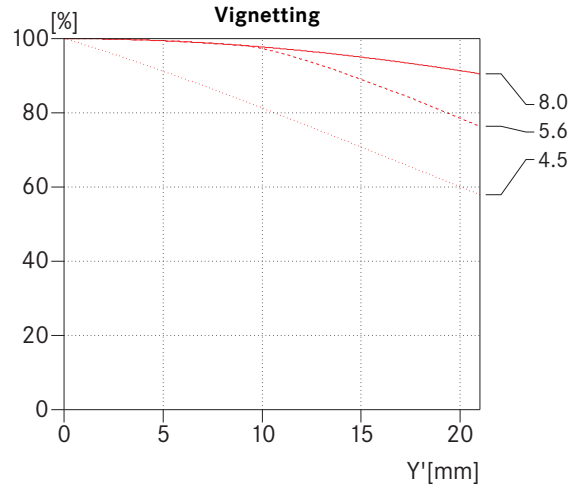
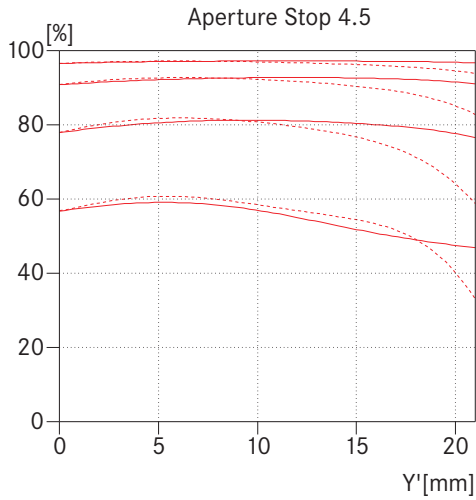



Depth of field table 28 mm

	Aperture Stop							Magnification
	2,8	4	5,6	8	11	16	22	
0,6	0,575 - 0,628	0,566 - 0,640	0,554 - 0,658	0,536 - 0,688	0,517 - 0,730	0,488 - 0,816	0,459 - 0,960	1/16,5
0,7	0,664 - 0,742	0,651 - 0,759	0,634 - 0,787	0,610 - 0,833	0,583 - 0,900	0,544 - 1,047	0,506 - 1,321	1/20,0
0,8	0,751 - 0,858	0,734 - 0,883	0,711 - 0,922	0,679 - 0,990	0,644 - 1,092	0,595 - 1,331	0,548 - 1,842	1/23,5
1	0,919 - 1,100	0,892 - 1,144	0,856 - 1,215	0,808 - 1,345	0,756 - 1,557	0,686 - 2,146	0,620 - 4,125	1/30,4
1,2	1,081 - 1,353	1,042 - 1,424	0,991 - 1,543	0,925 - 1,768	0,855 - 2,176	0,763 - 3,631	0,679 - 24,19	1/37,3
1,5	1,312 - 1,760	1,253 - 1,887	1,177 - 2,111	1,081 - 2,581	0,983 - 3,613	0,859 - 11,84	0,750 - ∞	1/47,6
2	1,668 - 2,516	1,570 - 2,796	1,449 - 3,345	1,301 - 4,781	1,157 - 10,67	0,983 - ∞	0,838 - ∞	1/64,9
2,5	1,992 - 3,390	1,852 - 3,934	1,682 - 5,151	1,481 - 9,793	1,294 - ∞	1,075 - ∞	0,902 - ∞	1/82,1
3,5	2,561 - 5,624	2,328 - 7,355	2,059 - 13,47	1,760 - ∞	1,496 - ∞	1,206 - ∞	0,987 - ∞	1/117
5	3,259 - 11,12	2,885 - 21,16	2,477 - ∞	2,050 - ∞	1,695 - ∞	1,326 - ∞	1,062 - ∞	1/168
8	4,279 - 76,54	3,647 - ∞	3,010 - ∞	2,394 - ∞	1,917 - ∞	1,453 - ∞	1,138 - ∞	1/272
15	5,657 - ∞	4,592 - ∞	3,615 - ∞	2,754 - ∞	2,135 - ∞	1,569 - ∞	1,205 - ∞	1/513
∞	8,949 - ∞	6,519 - ∞	4,693 - ∞	3,323 - ∞	2,452 - ∞	1,727 - ∞	1,292 - ∞	1/∞

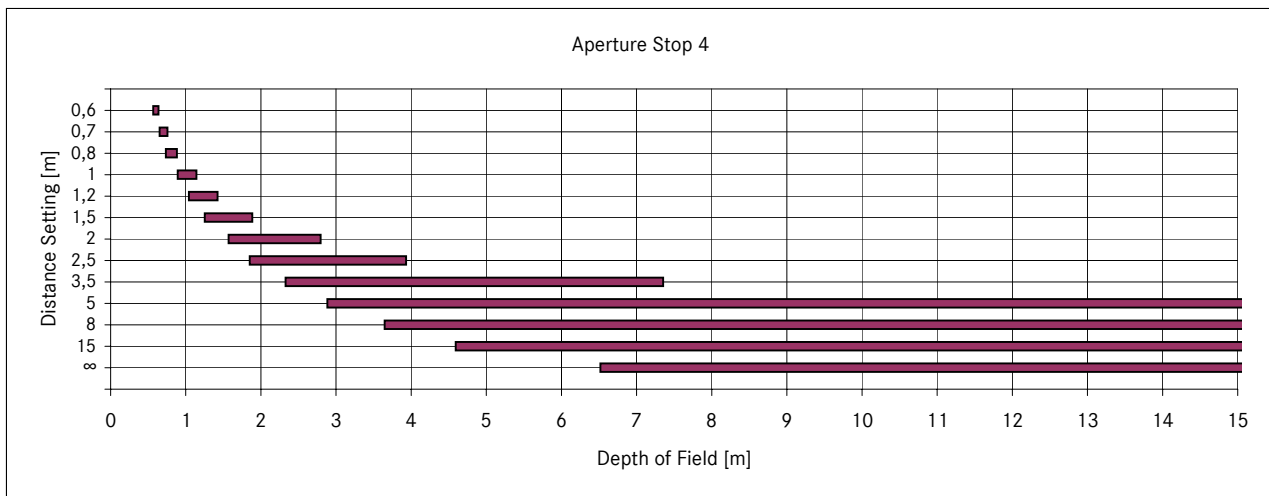
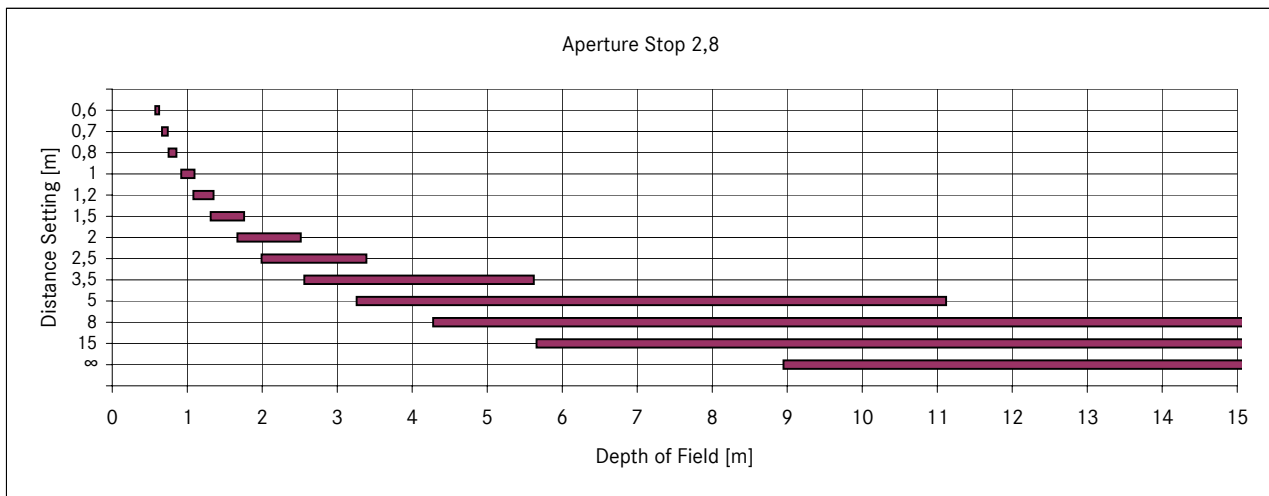



Aperture Stop 5,6

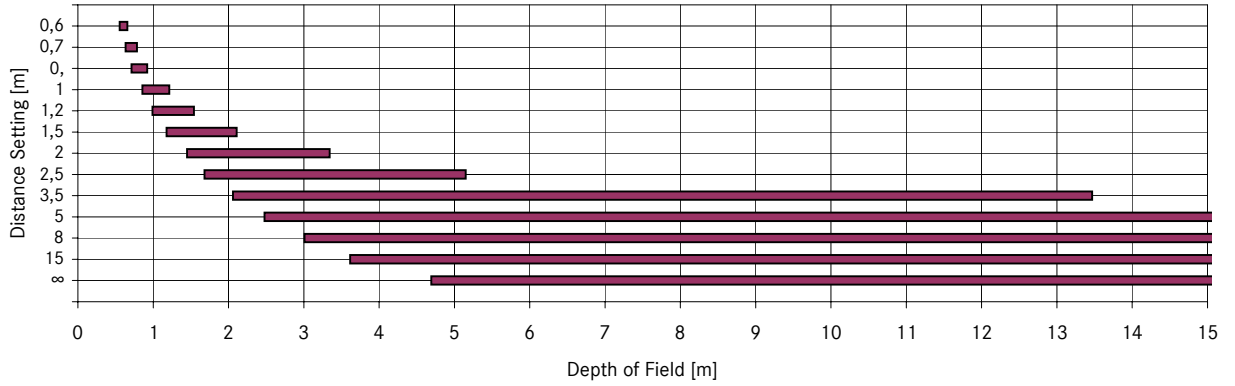

Aperture Stop 8

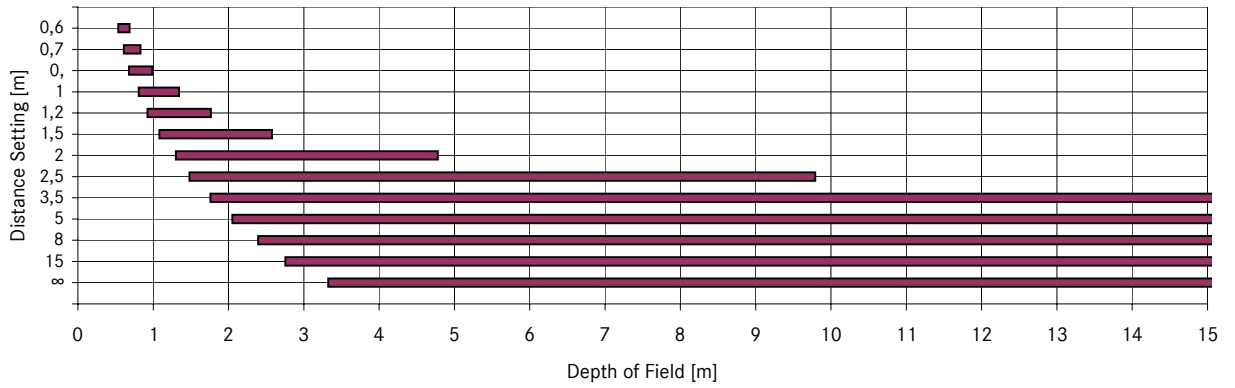

Aperture Stop 11

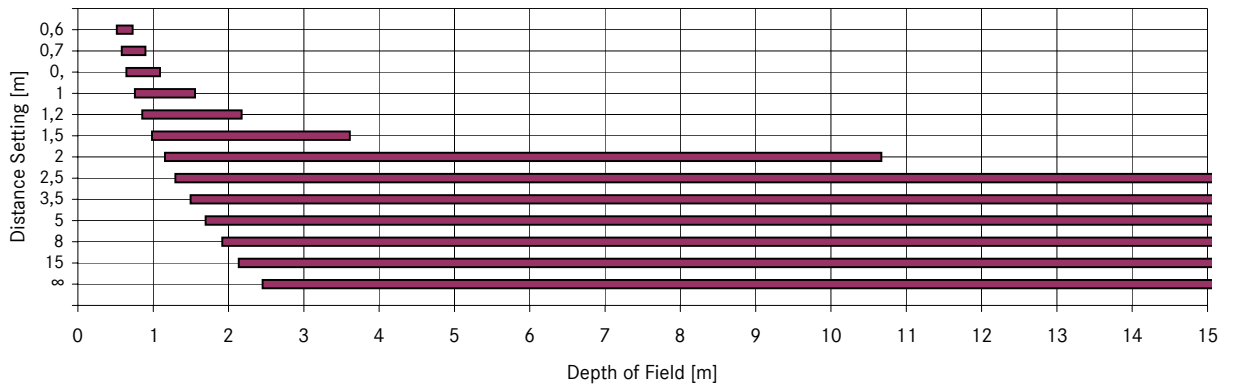



Aperture Stop 16

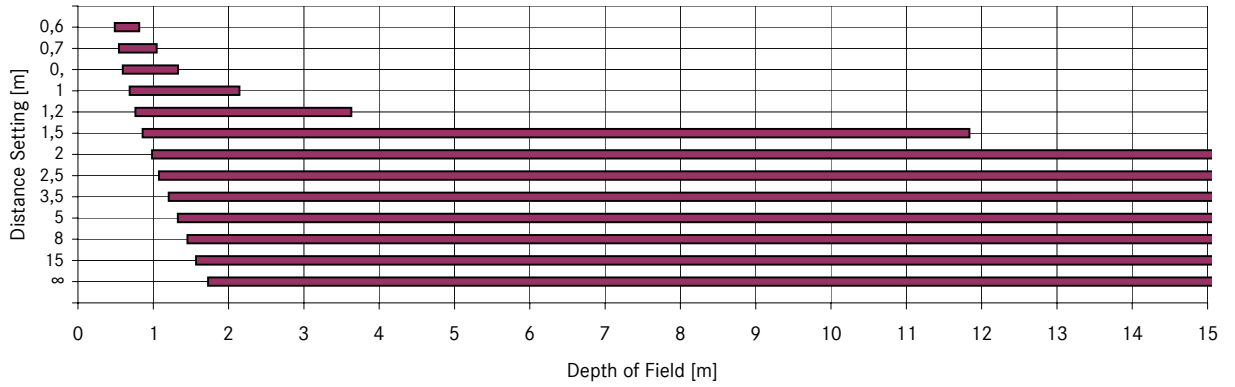

Aperture Stop 22

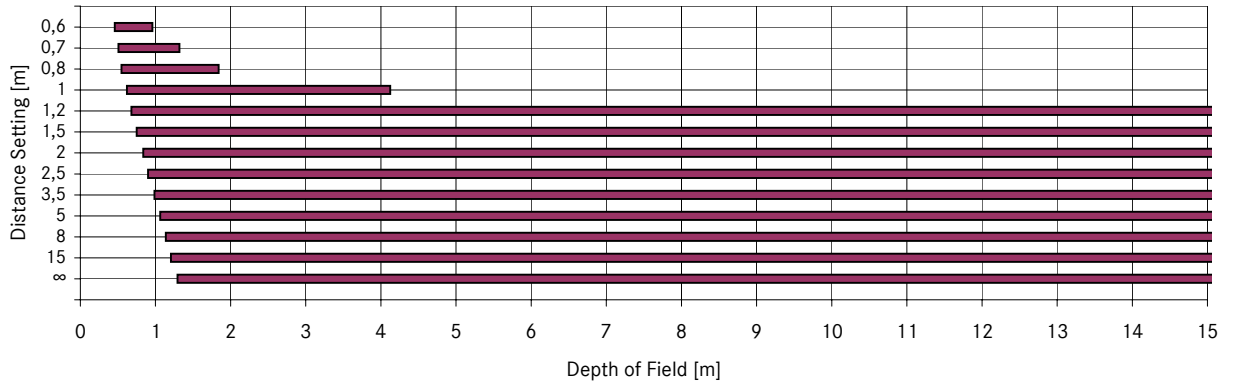



— Depth of field table 35 mm

	Aperture Stop							Magnification
	3,5	4	5,6	8	11	16	22	
0,6	0,578 - 0,625	0,575 - 0,628	0,565 - 0,641	0,552 - 0,660	0,536 - 0,687	0,513 - 0,738	0,488 - 0,813	1/14,0
0,7	0,668 - 0,736	0,664 - 0,741	0,651 - 0,760	0,632 - 0,789	0,610 - 0,830	0,578 - 0,911	0,545 - 1,037	1/16,9
0,8	0,757 - 0,849	0,751 - 0,857	0,734 - 0,883	0,709 - 0,925	0,681 - 0,984	0,639 - 1,106	0,597 - 1,308	1/19,7
1	0,930 - 1,084	0,921 - 1,097	0,893 - 1,142	0,855 - 1,218	0,812 - 1,330	0,750 - 1,580	0,690 - 2,062	1/25,5
1,2	1,097 - 1,328	1,084 - 1,348	1,044 - 1,420	0,990 - 1,544	0,931 - 1,738	0,849 - 2,213	0,770 - 3,354	1/31,2
1,5	1,337 - 1,713	1,317 - 1,749	1,257 - 1,877	1,177 - 2,110	1,091 - 2,506	0,976 - 3,694	0,870 - 8,997	1/39,8
2	1,712 - 2,416	1,678 - 2,491	1,578 - 2,768	1,450 - 3,331	1,318 - 4,494	1,149 - 11,17	1,000 - ∞	1/54,1
2,5	2,058 - 3,204	2,008 - 3,340	1,864 - 3,870	1,684 - 5,102	1,506 - 8,576	1,285 - ∞	1,098 - ∞	1/68,4
3,5	2,676 - 5,109	2,590 - 5,473	2,350 - 7,11	2,066 - 13,02	1,799 - ∞	1,487 - ∞	1,237 - ∞	1/97,0
5	3,454 - 9,221	3,310 - 10,50	2,922 - 19,07	2,489 - ∞	2,106 - ∞	1,684 - ∞	1,367 - ∞	1/140
8	4,633 - 31,19	4,374 - 53,72	3,712 - ∞	3,032 - ∞	2,475 - ∞	1,906 - ∞	1,505 - ∞	1/226
15	6,307 - ∞	5,831 - ∞	4,700 - ∞	3,652 - ∞	2,867 - ∞	2,124 - ∞	1,634 - ∞	1/426
∞	10,74 - ∞	9,417 - ∞	6,758 - ∞	4,766 - ∞	3,499 - ∞	2,443 - ∞	1,810 - ∞	1/∞

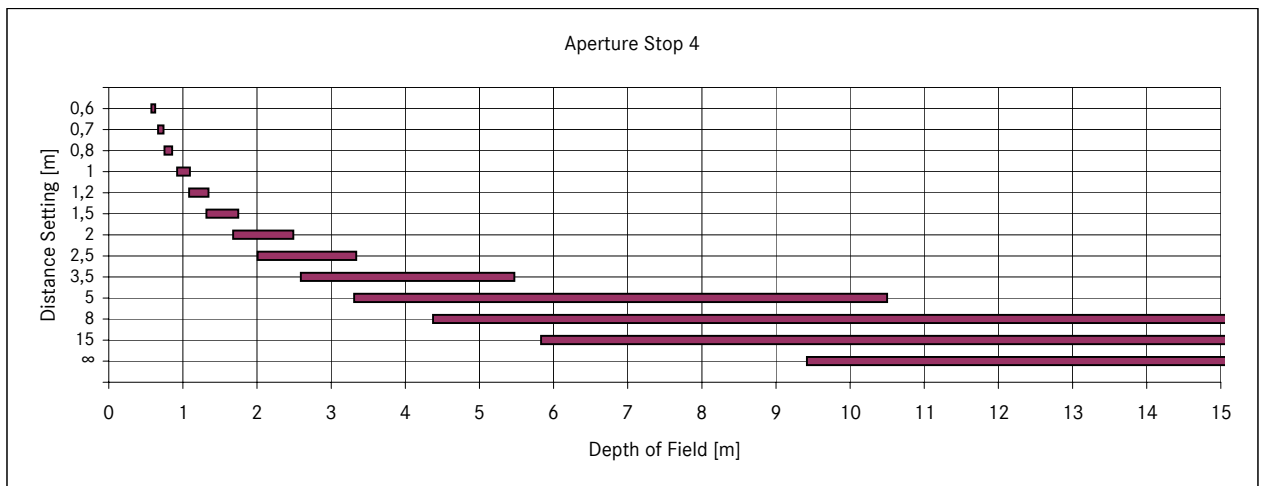
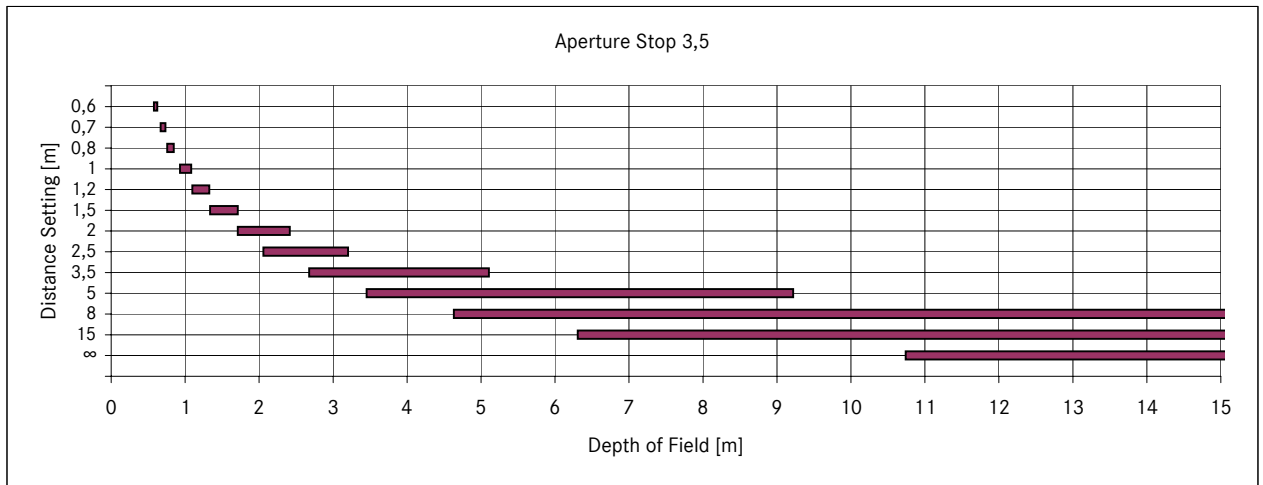

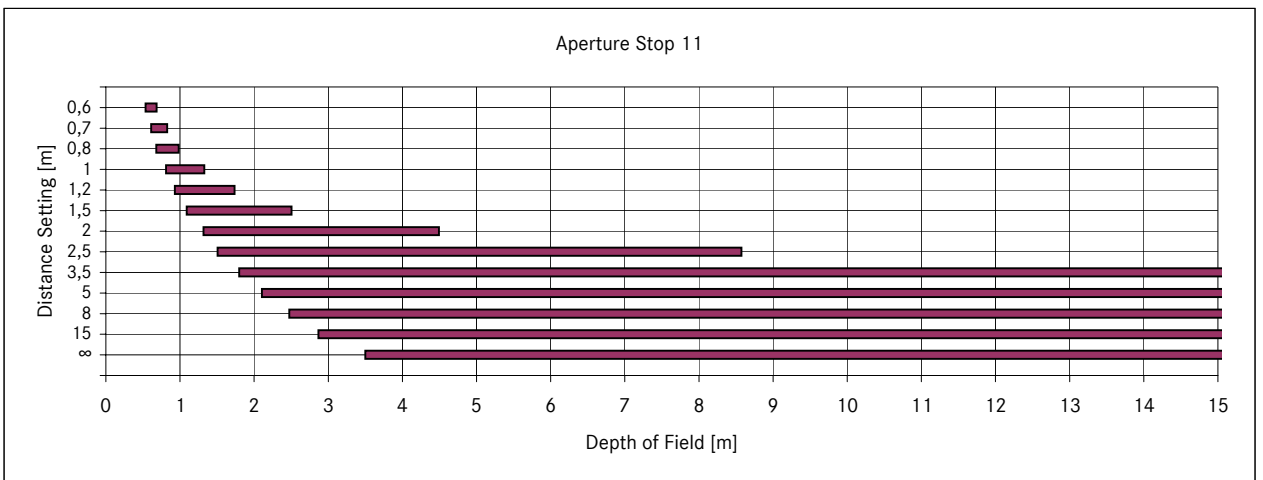
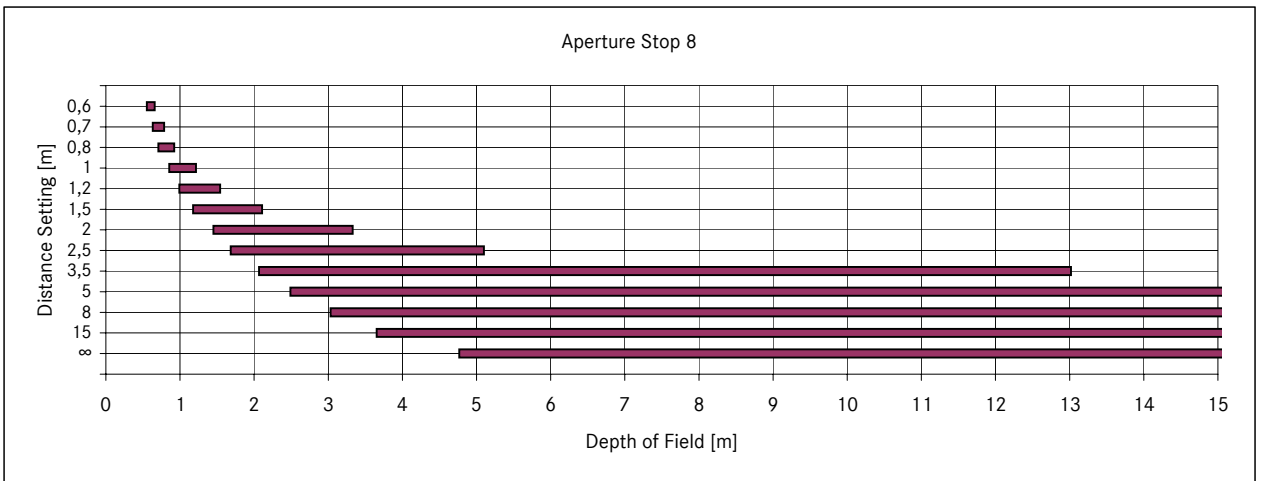
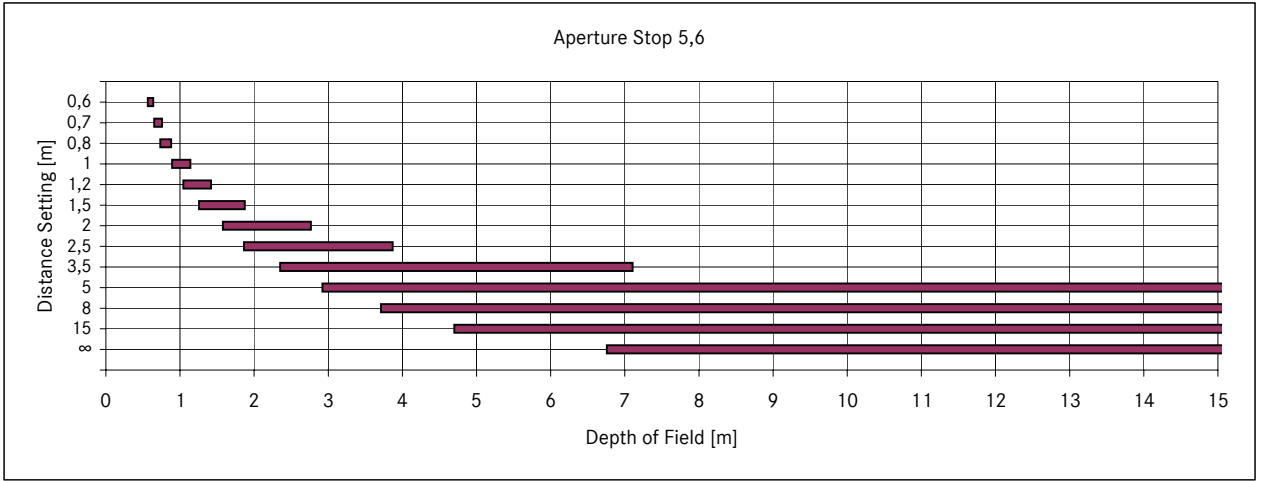

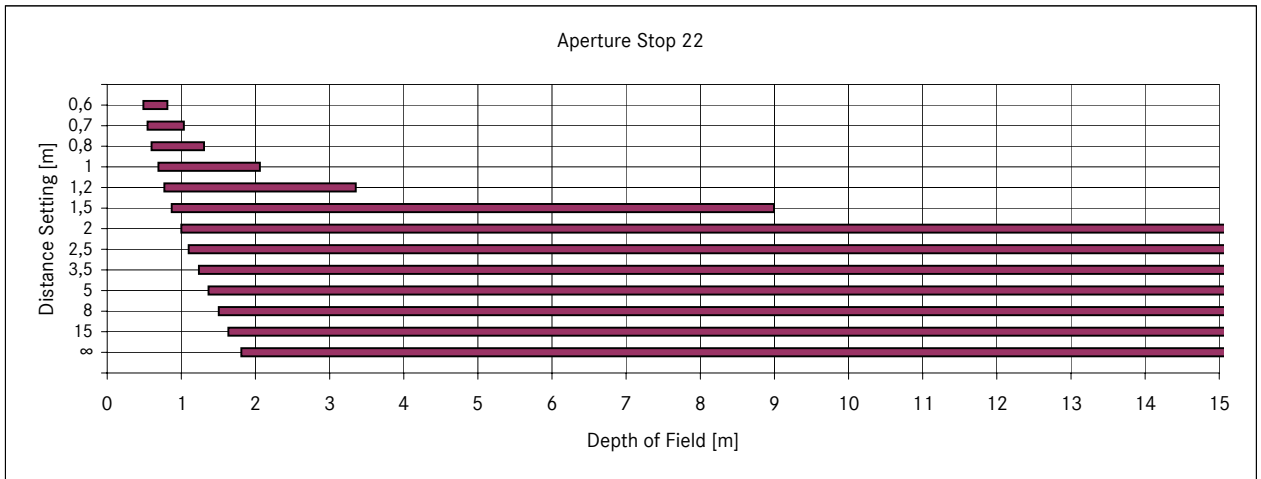
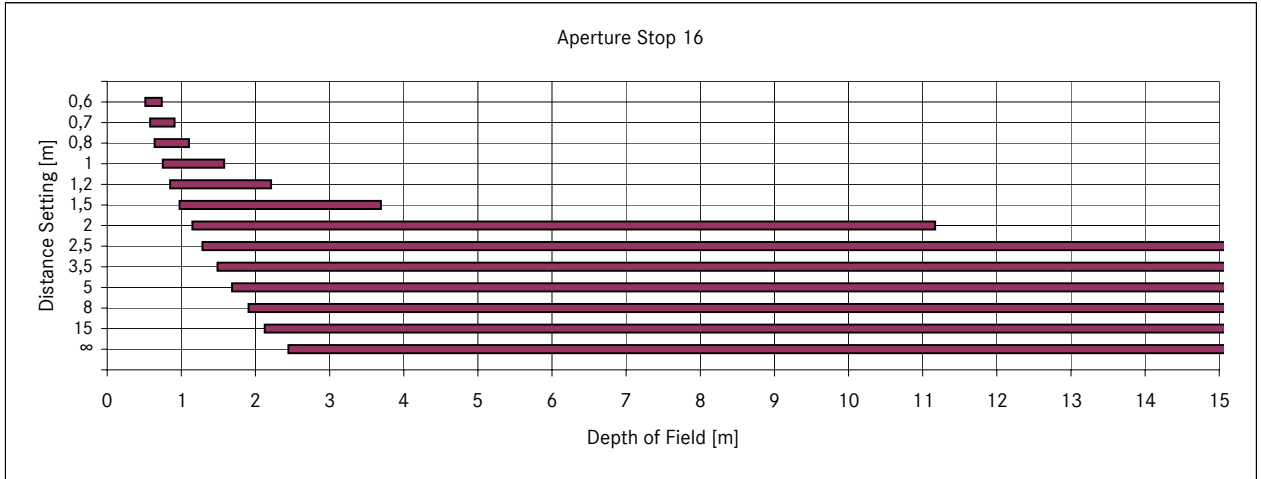





— Depth of field table 50 mm

	Aperture Stop							Magnification
	3,5	4	5,6	8	11	16	22	
0,6	0,588 - 0,613	0,586 - 0,614	0,581 - 0,620	0,574 - 0,630	0,564 - 0,642	0,550 - 0,663	0,534 - 0,691	1/9,96
0,7	0,683 - 0,718	0,681 - 0,721	0,673 - 0,729	0,663 - 0,743	0,650 - 0,761	0,630 - 0,793	0,608 - 0,835	1/12,0
0,8	0,777 - 0,824	0,774 - 0,828	0,764 - 0,840	0,750 - 0,859	0,733 - 0,883	0,707 - 0,928	0,678 - 0,990	1/14,0
1	0,963 - 1,041	0,958 - 1,047	0,942 - 1,067	0,919 - 1,099	0,893 - 1,141	0,852 - 1,222	0,809 - 1,337	1/18,0
1,2	1,145 - 1,261	1,138 - 1,270	1,115 - 1,301	1,083 - 1,350	1,045 - 1,417	0,988 - 1,548	0,929 - 1,744	1/22,0
1,5	1,413 - 1,599	1,402 - 1,615	1,366 - 1,666	1,316 - 1,750	1,259 - 1,869	1,175 - 2,111	1,090 - 2,508	1/28,0
2	1,844 - 2,187	1,824 - 2,216	1,763 - 2,317	1,678 - 2,489	1,584 - 2,745	1,450 - 3,32	1,318 - 4,463	1/38,0
2,5	2,258 - 2,804	2,227 - 2,854	2,134 - 3,027	2,010 - 3,333	1,874 - 3,817	1,687 - 5,059	1,508 - 8,388	1/48,0
3,5	3,035 - 4,142	2,979 - 4,253	2,812 - 4,66	2,596 - 5,44	2,370 - 6,899	2,073 - 12,600	1,806 - ∞	1/68,0
5	4,091 - 6,448	3,988 - 6,73	3,692 - 7,82	3,323 - 10,350	2,957 - 17,480	2,503 - ∞	2,119 - ∞	1/98,0
8	5,882 - 12,57	5,670 - 13,70	5,082 - 19,230	4,402 - 49,180	3,775 - ∞	3,058 - ∞	2,498 - ∞	1/158
15	8,921 - 48,18	8,437 - 70,54	7,187 - ∞	5,888 - ∞	4,810 - ∞	3,695 - ∞	2,901 - ∞	1/298
∞	21,78 - ∞	19,080 - ∞	13,650 - ∞	9,590 - ∞	7,005 - ∞	4,851 - ∞	3,559 - ∞	1/∞

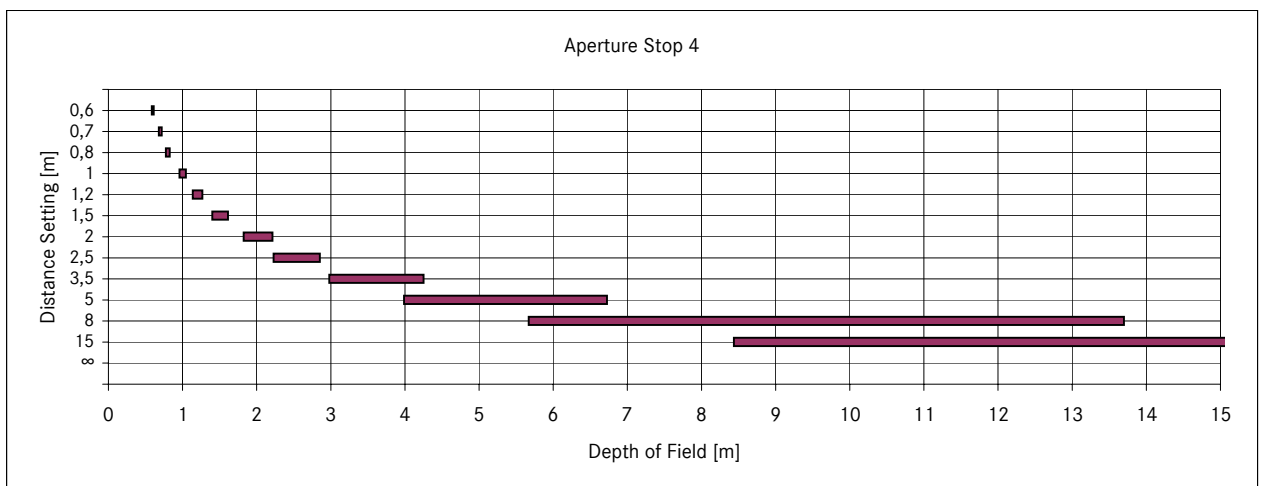
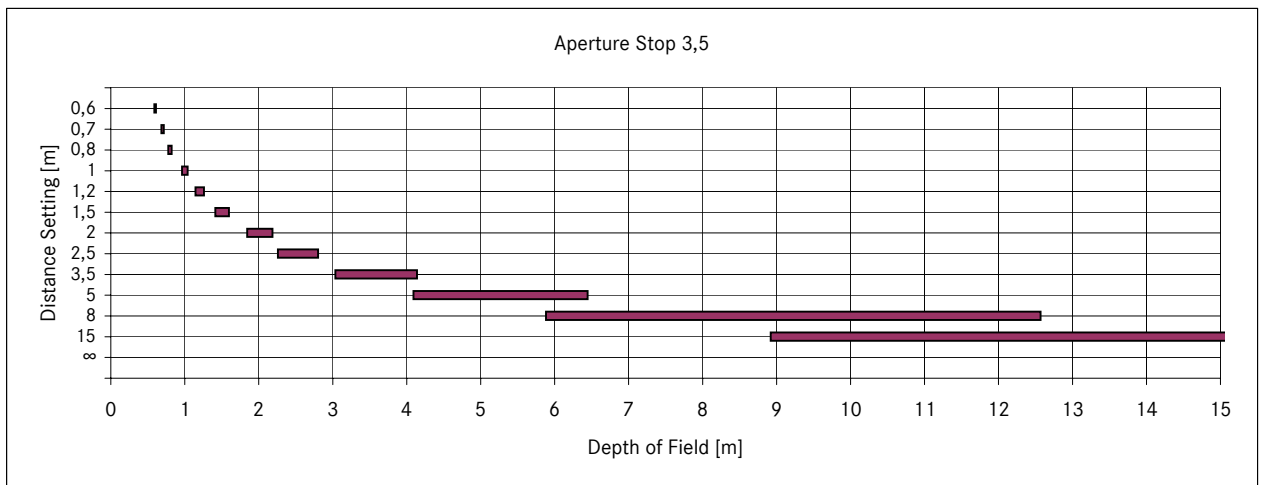

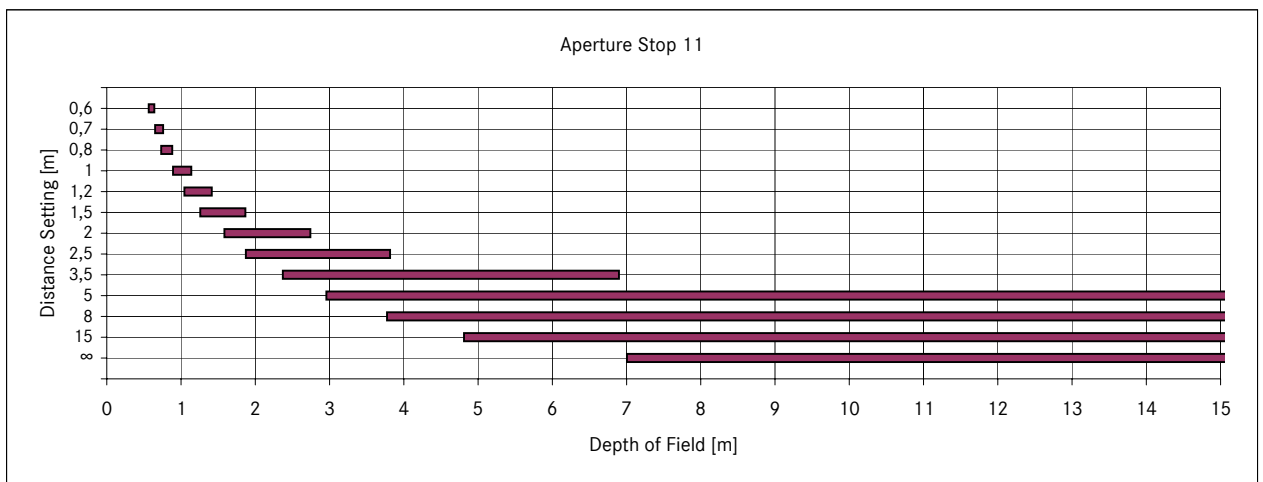
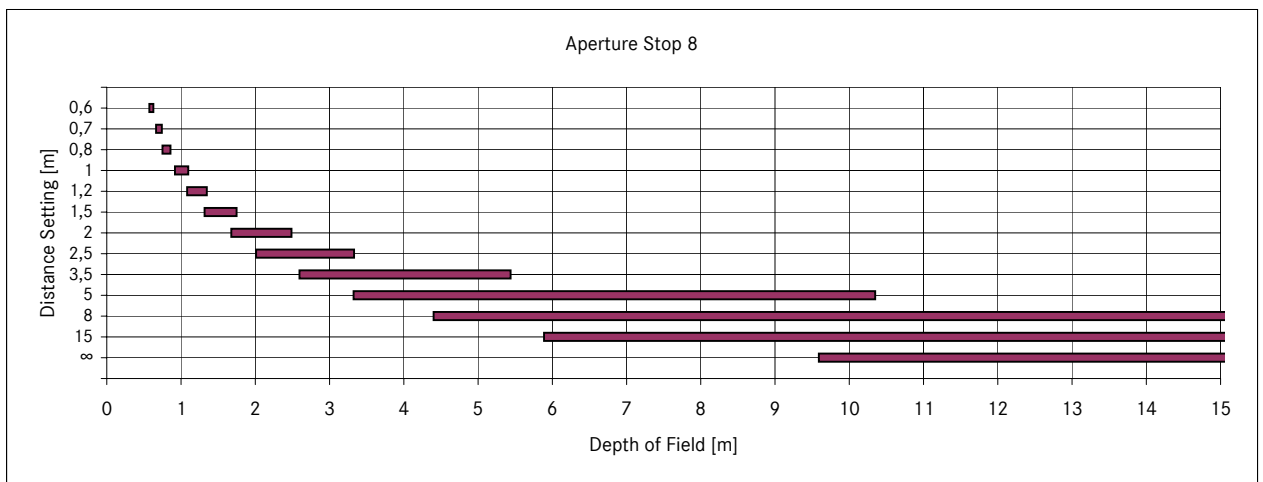
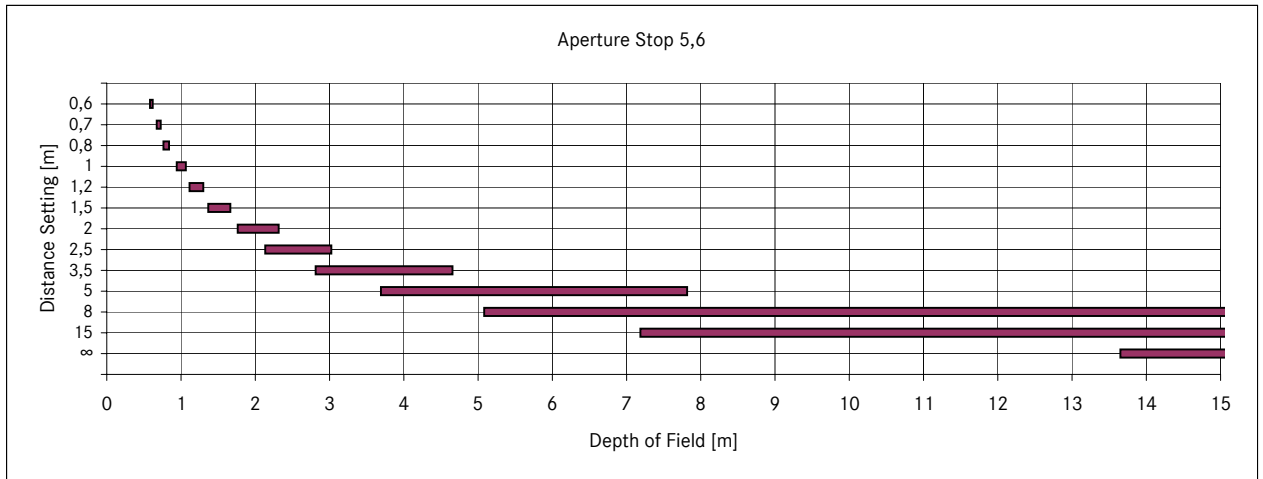

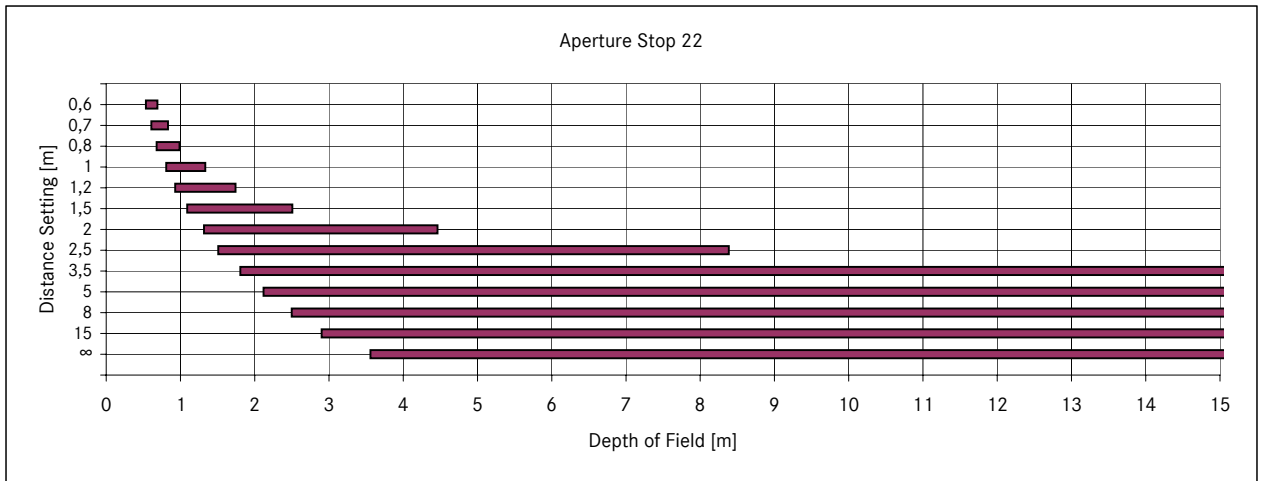
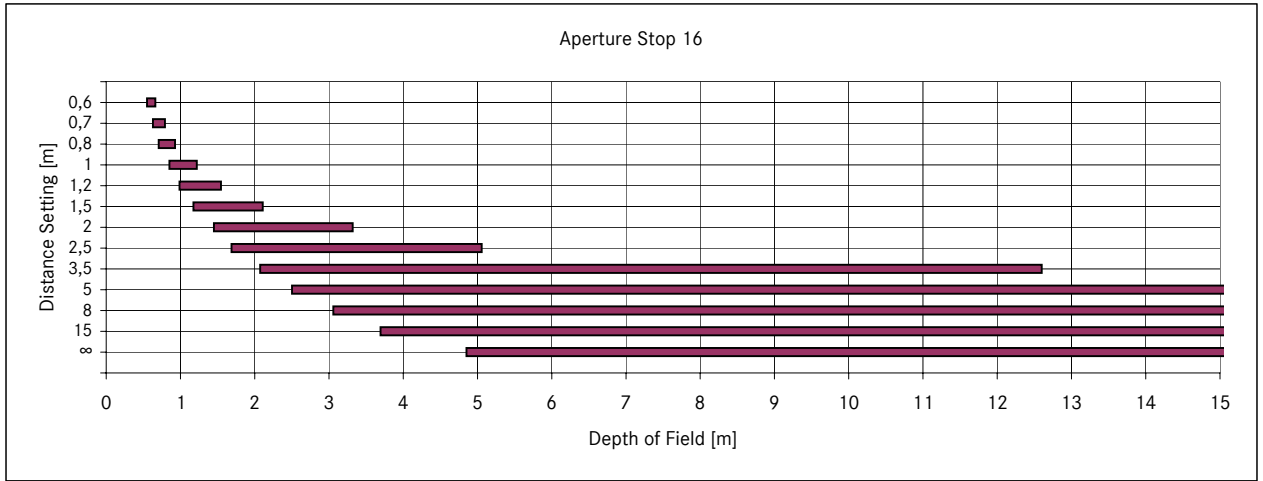



— Depth of field table 70 mm

	Aperute Stop							Magnification
	2,8 (4,0)	4 (5,3)	5,6 (7,4)	8 (10,6)	11 (14,5)	16 (21,1)	22 (29,1)	
0,6	0,593 - 0,607	0,590 - 0,610	0,587 - 0,614	0,581 - 0,620	0,575 - 0,628	0,564 - 0,642	0,552 - 0,660	1/7,06
0,7	0,690 - 0,711	0,686 - 0,714	0,681 - 0,720	0,674 - 0,729	0,664 - 0,741	0,650 - 0,761	0,633 - 0,788	1/8,50
0,8	0,786 - 0,814	0,782 - 0,819	0,775 - 0,827	0,765 - 0,840	0,752 - 0,855	0,733 - 0,884	0,711 - 0,921	1/9,93
1	0,978 - 1,024	0,970 - 1,032	0,959 - 1,045	0,943 - 1,066	0,924 - 1,092	0,893 - 1,141	0,859 - 1,207	1/12,8
1,2	1,167 - 1,235	1,157 - 1,247	1,140 - 1,267	1,117 - 1,299	1,089 - 1,340	1,046 - 1,416	0,998 - 1,522	1/15,7
1,5	1,447 - 1,557	1,431 - 1,577	1,406 - 1,609	1,369 - 1,662	1,326 - 1,732	1,261 - 1,865	1,191 - 2,060	1/20,0
2	1,905 - 2,106	1,876 - 2,142	1,832 - 2,205	1,768 - 2,308	1,696 - 2,449	1,588 - 2,732	1,475 - 3,185	1/27,1
2,5	2,351 - 2,670	2,307 - 2,731	2,239 - 2,835	2,143 - 3,010	2,037 - 3,258	1,881 - 3,790	1,722 - 4,737	1/34,2
3,5	3,211 - 3,849	3,127 - 3,978	3,001 - 4,208	2,828 - 4,614	2,643 - 5,235	2,382 - 6,793	2,130 - 10,70	1/48,5
5	4,423 - 5,755	4,264 - 6,053	4,030 - 6,608	3,721 - 7,686	3,404 - 9,607	2,978 - 16,75	2,590 - 188,9	1/70,0
8	6,606 - 10,16	6,254 - 11,13	5,759 - 13,19	5,141 - 18,4	4,549 - 35,68	3,813 - ∞	3,193 - ∞	1/113
15	10,72 - 25,06	9,817 - 32,07	8,641 - 58,69	7,311 - ∞	6,162 - ∞	4,875 - ∞	3,900 - ∞	1/213
∞	37,25 - ∞	28,14 - ∞	20,19 - ∞	14,13 - ∞	10,36 - ∞	7,155 - ∞	5,220 - ∞	1/∞

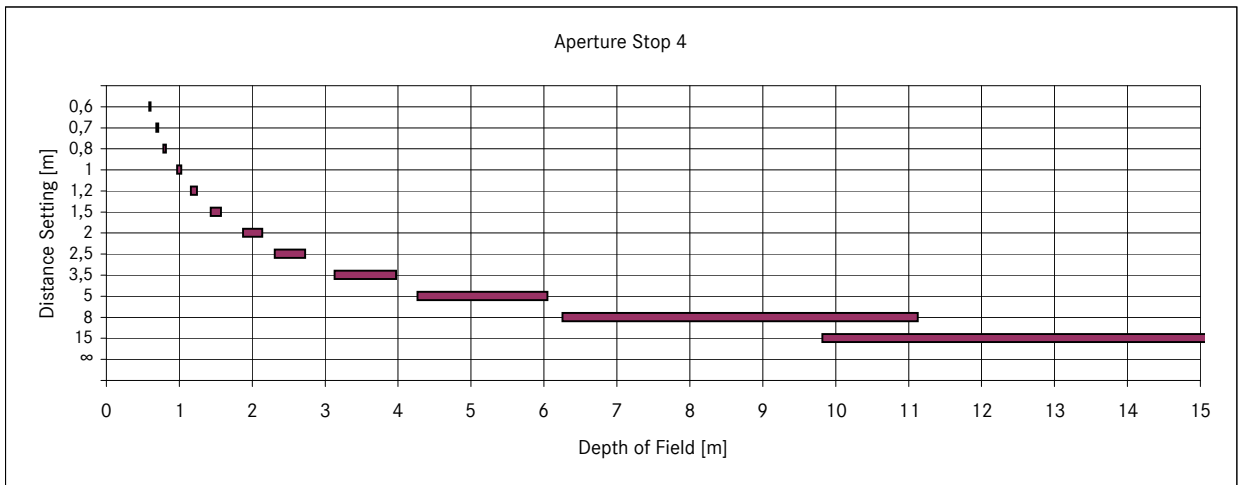
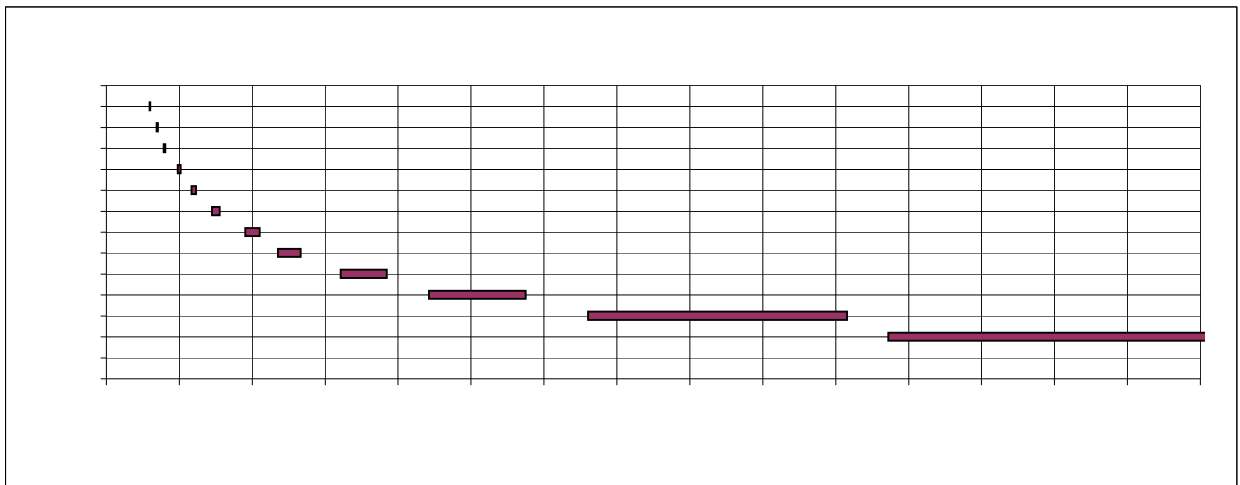

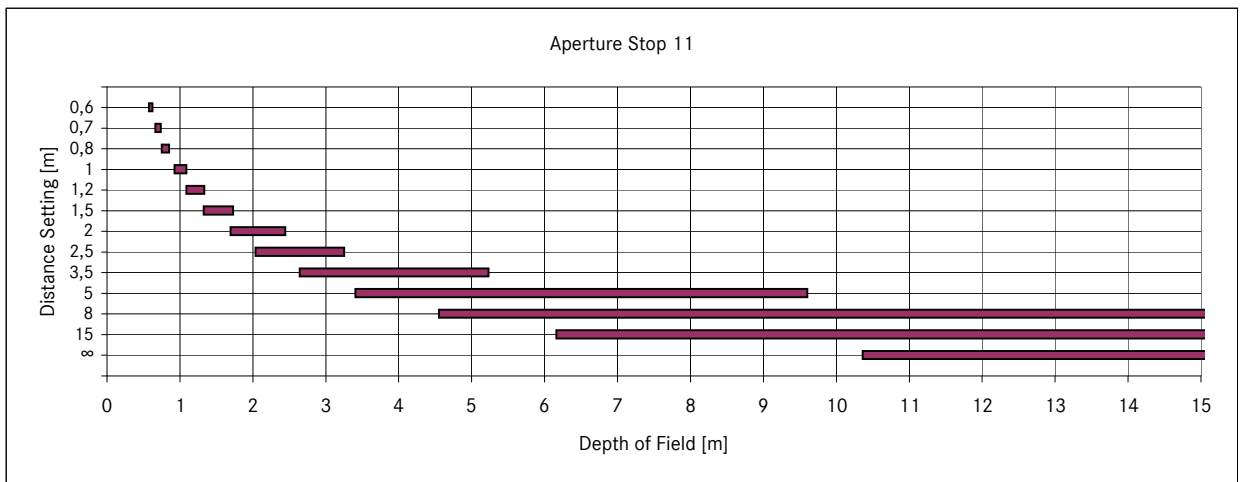
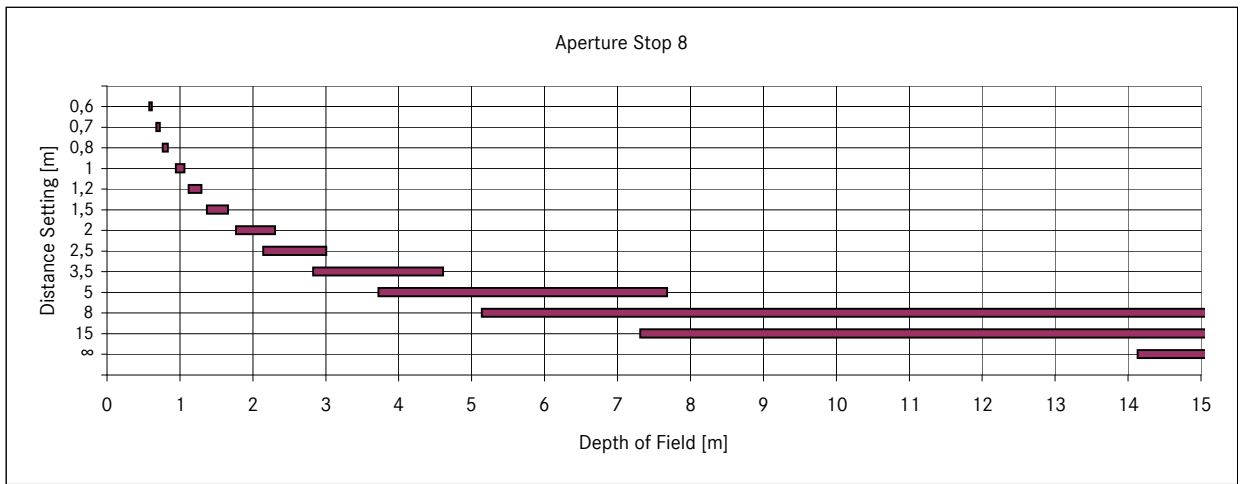
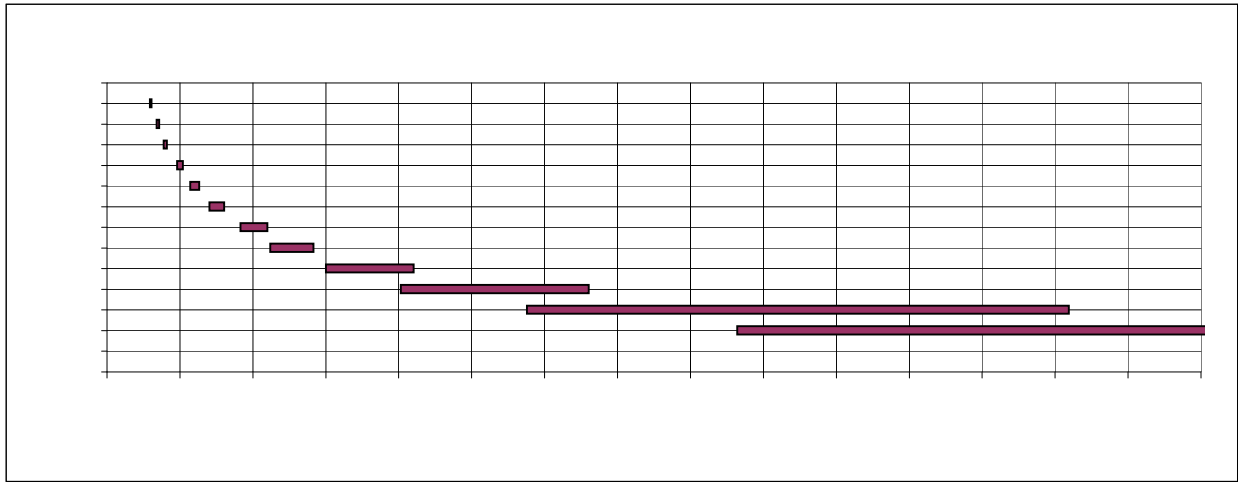

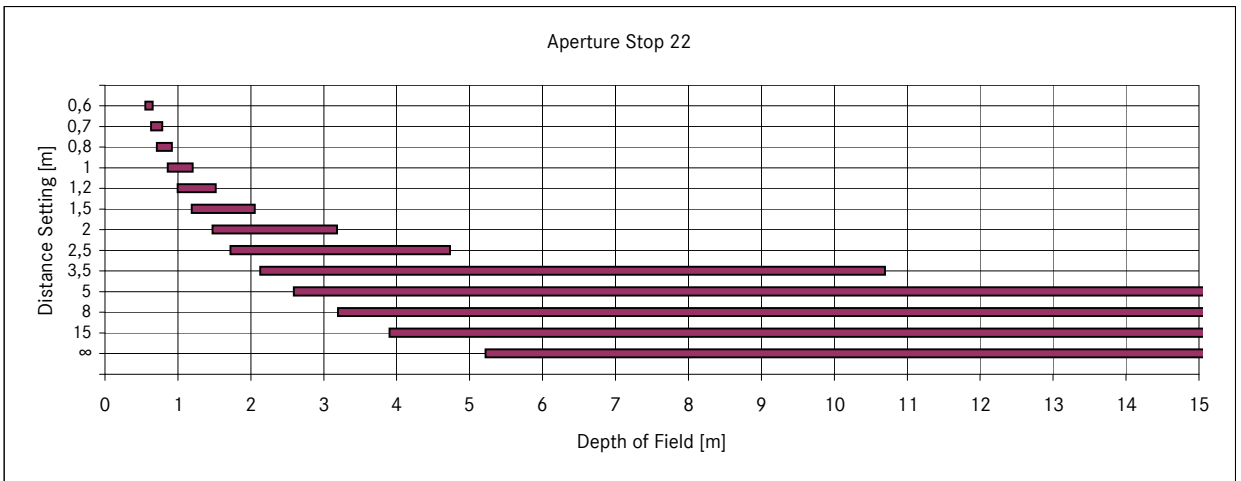
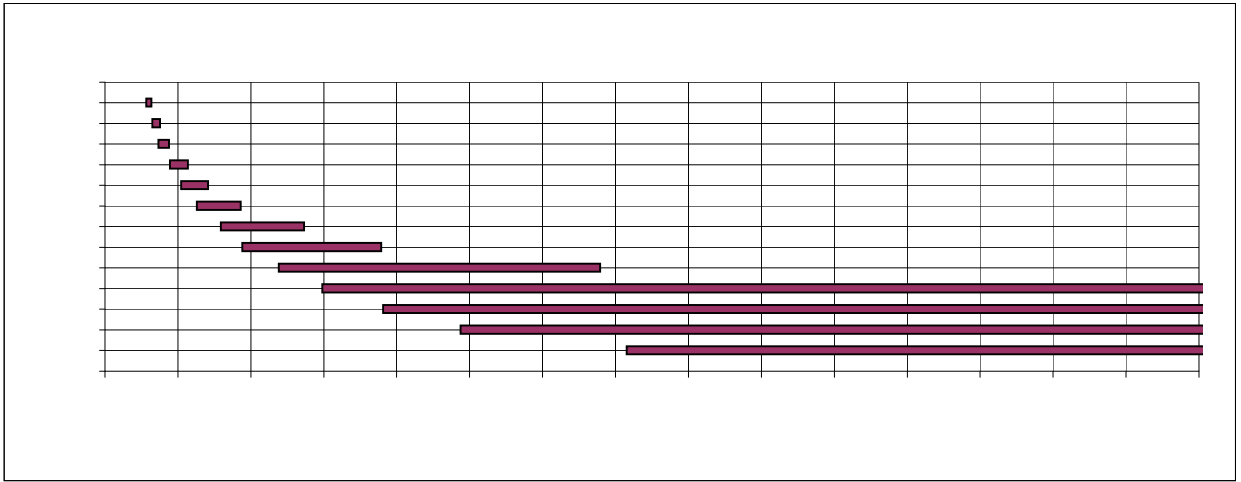



Depth of field table 90 mm

Distance Setting [m]	Aperture Stop						Magnification
	4,6	5,6	8	11	16	22	
0,6	0,595 - 0,605	0,594 - 0,607	0,591 - 0,610	0,587 - 0,613	0,582 - 0,620	0,576 - 0,627	1/5,51
0,7	0,692 - 0,708	0,691 - 0,709	0,687 - 0,714	0,682 - 0,719	0,675 - 0,728	0,666 - 0,739	1/6,65
0,8	0,790 - 0,811	0,788 - 0,813	0,782 - 0,818	0,776 - 0,826	0,766 - 0,838	0,754 - 0,853	1/7,79
1	0,983 - 1,017	0,980 - 1,021	0,972 - 1,030	0,961 - 1,042	0,945 - 1,063	0,926 - 1,089	1/10,1
1,2	1,176 - 1,226	1,170 - 1,231	1,158 - 1,245	1,143 - 1,263	1,120 - 1,294	1,093 - 1,334	1/12,4
1,5	1,461 - 1,541	1,453 - 1,551	1,434 - 1,573	1,410 - 1,603	1,374 - 1,655	1,332 - 1,722	1/15,8
2	1,930 - 2,076	1,915 - 2,093	1,881 - 2,136	1,840 - 2,193	1,776 - 2,294	1,706 - 2,429	1/21,5
2,5	2,390 - 2,622	2,367 - 2,650	2,314 - 2,720	2,252 - 2,813	2,156 - 2,985	2,051 - 3,222	1/27,1
3,5	3,284 - 3,748	3,241 - 3,806	3,141 - 3,955	3,026 - 4,160	2,851 - 4,553	2,668 - 5,140	1/38,5
5	4,566 - 5,529	4,481 - 5,66	4,291 - 5,999	4,076 - 6,488	3,762 - 7,51	3,446 - 9,284	1/55,6
8	6,933 - 9,46	6,739 - 9,86	6,314 - 10,95	5,854 - 12,72	5,222 - 17,43	4,626 - 31,51	1/89,7
15	11,62 - 21,19	11,08 - 23,29	9,968 - 30,55	8,859 - 50,19	7,479 - ∞	6,307 - ∞	1/169
∞	51,10 - ∞	42,00 - ∞	29,44 - ∞	21,44 - ∞	14,78 - ∞	10,78 - ∞	1/∞

